

MACAO 6060

59 3/4" x 59 3/4" x 21"



PRODUCT DESCRIPTION:

Adjustable feet
Contemporary style
Gloss finish resistant to stains and discoloration
Acrylic thermoformed and reinforced with fiberglass
Available with 2" flange only

5 days

WATER CAPACITY: 138 gallons	IMMERSION: 17 5/8 po
BOX SIZE: 61 1/2" x 61 1/2" x 22 1/2"	
NET WEIGHT: 87 lbs	GROSS WEIGHT: 107 lbs

Includes drain and Ultim-O overflow assembly.

GENERAL OPTIONS

Ultim-O overflow and waste included: Chrome

Acrylic Colors: White Standard
Biscuit* and Bone* (Allow 3 weeks delivery) Standard

Others*: (Allow 6 to 8 weeks delivery)

Chromotherapy 1 light (Specify trim color) 17.99999.0000.00

Chromotherapy 2 lights (Specify trim color) 17.99999.0001.00

Chromotherapy 4 lights (Specify trim color) 17.99999.0002.00

Handle (max. 2) (submit drawing with order) 95.7077.106.XX

Tiling Flange (submit drawing with order)

Rayola** (Specify control color)

Available for bathtub without system only

WHIRLPOOL OPTIONS

A bathtub fitted with back jets may cause the pump to protrude by +/- 3" from the overall dimension.

Pumps are installed on the right side of the overflow (non-negotiable)

Whirlpool Jet finish: Chrome, White, Biscuit, Bone Standard

110v Inline Heater (max. 2)

Ozonator

Turbo Air (1)

MASS-AIR/ACTIV-AIR OPTIONS

Mass-Air Jet finish: White/Chrome Standard
Biscuit/Chrome
Bone/Chrome

Others: Chrome/Chrome

Activ-Air Jet finish: Chrome, White, Biscuit, Bone Standard

Blower Hose extension 36" 95.5013.116.00

Blower Hose extension 72" 95.5013.167.00

Blower Hose extension 96" 95.5013.168.00

144" Extension cord 95.3012.101.00

An extension cord and blower hose extension are necessary when the blower is located more than 2' from the electronic control, not available on whirlpool combos.

*Customized products, non cancellable, non returnable.

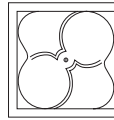

Bathtub only

MA6020

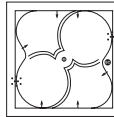

Whirlpool

MA6020T

Included: 6 square turbo jets, 16 square micro-rotating back jets, two 13 A pumps, two diverter valves and electronic control.

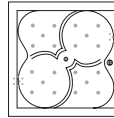

Mass-Air

MA6020M

Included: 36 (20-16) injectors, two Optima blowers 750W (1 1/2 h.p) with 300W heating element and backlit electronic control.

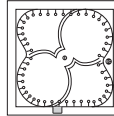

Activ-Air

MA6020A

Included: 48 Activ-Air micro-jets, 14 back jets, Optima blower 750W (1 1/2 h.p) with 300W heating element and backlit electronic control.

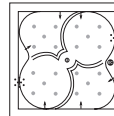

Mass-Air/Whirlpool Combo

MA6020C Included: 6 square turbo jets, 16 square micro-rotating back jets, 20 injectors, Optima blowers 750W (1 1/2 h.p) with 300W heating element, two 13 A pumps, two diverter valves and backlit electronic control.

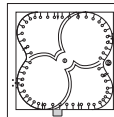

Activ-Air/Whirlpool Combo

MA6020CA

Included: 6 square turbo jets, 16 square micro-rotating back jets, 48 Activ-Air chrome micro-jets, two 13 A pumps, Optima blower 750W (1 1/2 h.p) with 300W heating element, two diverter valves and backlit electronic control.

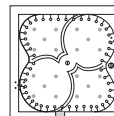

Mass-Air/Activ-Air Combo

MA6020CMA Included: 48 Activ-Air micro-jets, 14 Activ-Air back jets, 20 Mass-Air injectors, two Optima blowers 750W (1 1/2 h.p) with 300W heating element and backlit electronic control.

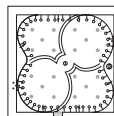

Activ-Air/Mass-Air/Whirlpool Combo

MA6020TAM Included: 6 square turbo jets, 16 square micro-rotating back jets, 48 Activ-Air chrome micro-jets, 20 Mass-Air injectors, two 13 A pumps, two Optima blowers 750W (1 1/2 h.p) with 300W heating element, two diverter valves and backlit electronic control.



Intertek

COMPLIANCE ATTESTATION
Standard bathtubs
CAN / CSA.B45.5
Hydromassage Standards
CAN / CSA.B45.10 / CSA.C22.2 / UL-1795



Certification ECORESPONSIBLE
First manufacturer of bathroom products in North America to be certified ecoresponsible.



Produits Neptune

6835, Picard street, Saint-Hyacinthe (Quebec) J2S 1H3
Phone: (450) 773-7058 - Fax: (450) 773-5063
produitsneptune.com



Produits Neptune

MACAO 6060

Bathtub

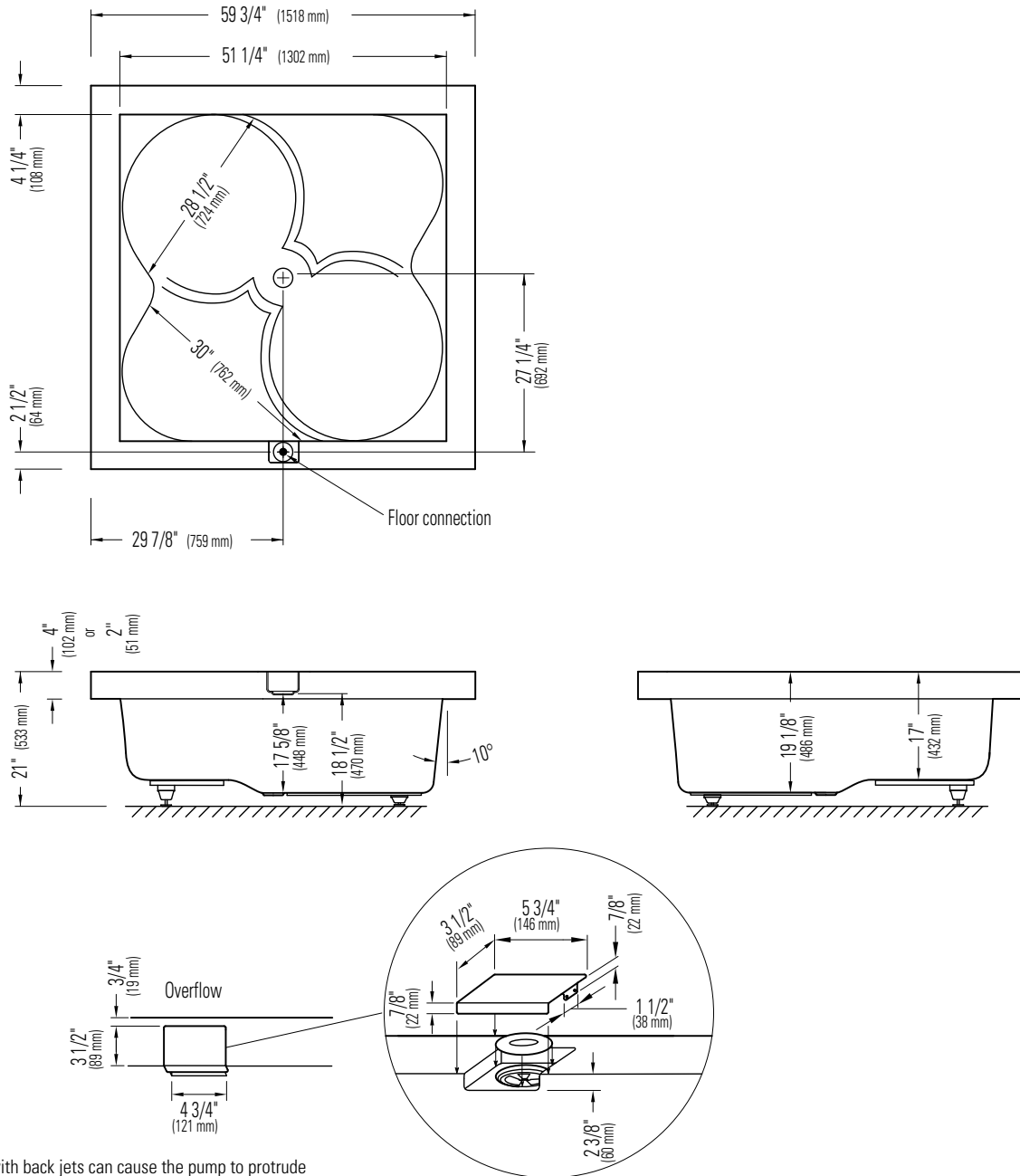

*A bathtub fitted with back jets can cause the pump to protrude by approximately 3" from the overall dimension.

**All dimensions are approximate and subject to change without notice. Please refer to the installation guide before beginning the installation