

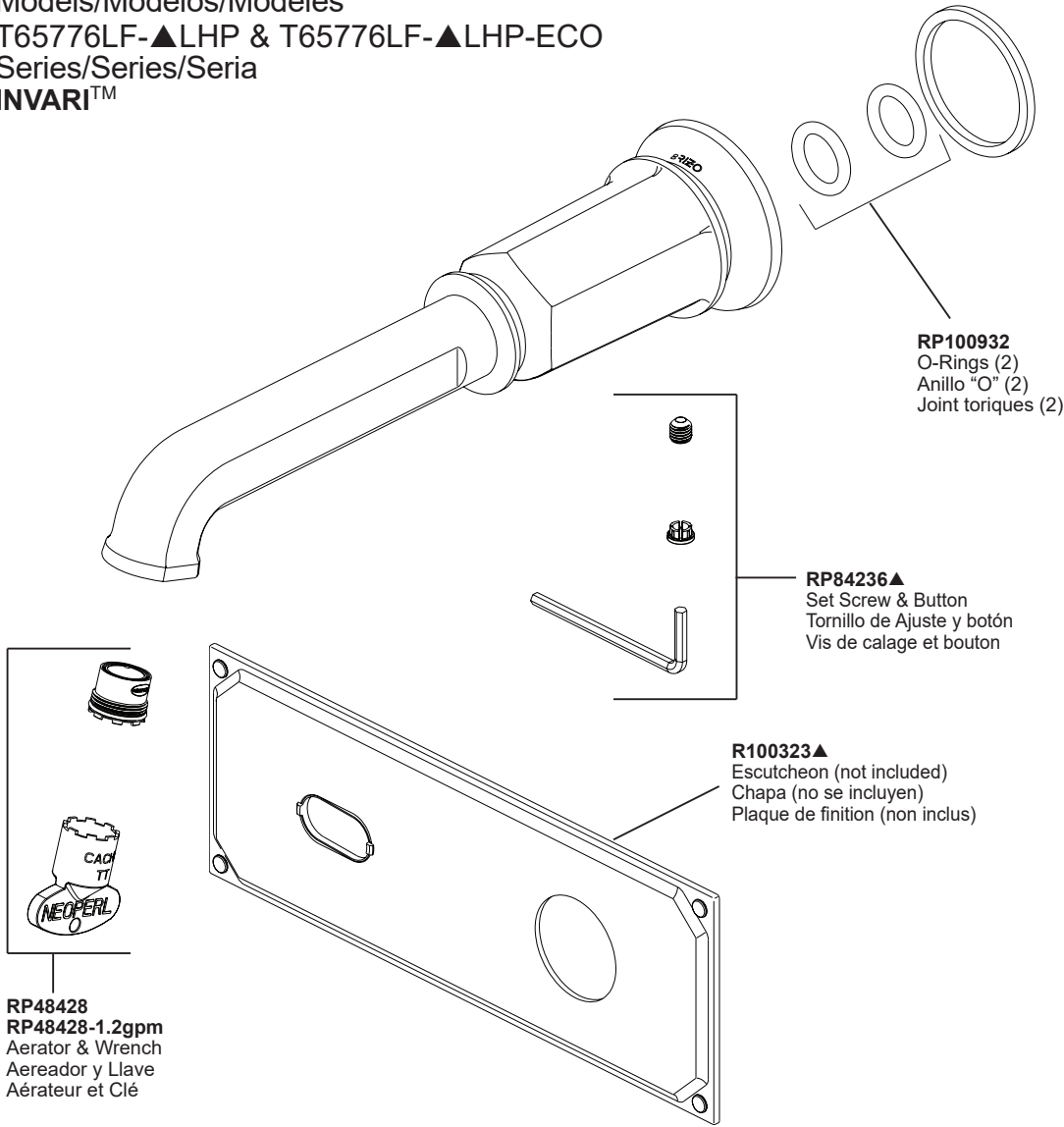

Models/Modelos/Modèles
 T65776LF-▲LHP & T65776LF-▲LHP-ECO
 Series/Series/Seria
INVARI™

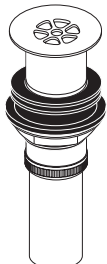
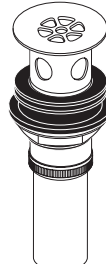
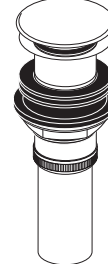
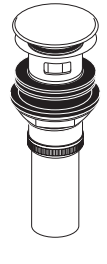

▲ Specify Finish / Especificque el Acabado / Précisez le Fini

Optional - Drain Sold Separately / Opcional - El desagüe se vende por separado / Facultative - Renvoi vendu séparément



 <p>RP72411▲ Grid Strainer without Overflow (Optional, not included) Cesta/colador para el Desagüe sin Rebosadero (Opcional, no incluido) Crépine sans trop-plein (Option, non inclus)</p>	 <p>RP72412▲ Grid Strainer with Overflow (Optional, not included) Cesta/colador para el Desagüe con Rebosadero (Opcional, no incluido) Crépine avec trop-plein (Option, non inclus)</p>	 <p>RP72413▲ Push Pop-Up without Overflow (Optional, not included) Control de rebose sin desagües manuales (Opcional, no incluido) Renvoi mécanique à pousser sans trop-plein (Option, non inclus)</p>
 <p>RP72414▲ Push Pop-Up with Overflow (Optional, not included) Control de rebose para desagües manuales (Opcional, no incluido) Renvoi mécanique à pousser avec trop-plein (Option, non inclus)</p>	 <p>RP81627▲ Push Pop-Up without Overflow (Optional, not included) Control de rebose sin desagües manuales (Opcional, no incluido) Renvoi mécanique à pousser sans trop-plein (Option, non inclus)</p>	 <p>RP81628▲ Push Pop-Up with Overflow (Optional, not included) Control de rebose para desagües manuales (Opcional, no incluido) Renvoi mécanique à pousser avec trop-plein (Option, non inclus)</p>

**Handles (sold separately)
 Manijas (se vende por separado)
 Manettes (vendu séparément)**

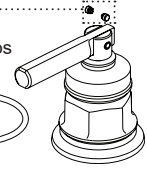
RP100928▲
 Button Post
 Botón de correos
 Bouton poste



RP100933
 O-Ring
 Anillo "O"
 Joint torique



HL5876▲ (Lever/Palanca/Manette levier)
 Handles & Glide Rings
 Manijas y aros deslizantes
 Manettes et anneaux de glissement



RP101184▲
 Cap and Friction Ring (1)
 Tapa y aro de fricción (1)
 Chapeau et anneau de friction (1)



RP100933
 O-Ring
 Anillo "O"
 Joint torique

HX5876▲ (Cross Handle/Mango Cruzado/Traverser de Manette)
 Handles & Glide Rings
 Manijas y aros deslizantes
 Manettes et anneaux de glissement



HK5876▲ (Knob Handle/Mango Perilla/Poignée de Manette)
 Handles & Glide Rings
 Manijas y aros deslizantes
 Manettes et anneaux de glissement



RP100933
 O-Ring
 Anillo "O"
 Joint torique